

POWER RELAY

1 POLE - 3, 5A Medium Load Control (AgCdO contacts)

JY Series

■ FEATURES

- UL, CSA recognized
- High sensitivity and low power consumption
- High insulation
- Wide operating range
- DIL pitch terminals
- Plastic sealed type, RTIII
- Socket mounting type and socket available
- Compatible with solid state relays type SJ
- RoHS compliant.

Please see page 7 for more information



■ Part Numbers

[Example] JY - 12 H E - K P - UL
 (a) (b) (c) (d) (e) (f) (g)

(a)	Relay type	JY : JY series
(b)	Coil rated voltage	12 : 4.5...48VDC
(c)	Contact style	Nil : 3A (single contact) H : 5A (single contact)
(d)	Coil material	Nil : Gold flash silver cadmium oxide (single contact type) E : Silver cadmium oxide (single contact type)
(e)	Enclosure	K : Plastic sealed type, RTIII
(f)	Terminal type	Nil : PC board mounting type P : Socket mounting type (without JY-W)
(g)	Safety approval	Nil : UL, CSA not approved type UL : UL, CSA approved type

■ Specifications

Item			JY - ()	JY - () E	JY - () H	JY - () HE	Remarks / conditions
			3A type		5A type		
Contact data	Configuration		1a				
	Construction		Single				
	Material		Gold flash silver cadmium oxide	Silver cadmium oxide	Gold flash silver cadmium oxide	Silver cadmium oxide	
	Resistance		Max. 30 mΩ	Max. 100 mΩ	Max. 30 mΩ	Max. 100 mΩ	Initial (at 6 VDC, 1A)
	Contact rating		3A, 250VAC / 30VDC		5A, 250VAC / 30VDC		
	Max. carrying current		5A				
	Max. switching voltage		250VAC / 150VDC				
	Max. switching power		750VA, 90W		1,250VA, 150W		
	Max. switching current		3A		5A (Socket 3A)		
	Min. switching load *		10mA 5VDC	100mA 5VDC	10mA 5VDC	100mA 5VDC	
Coil	Rated power consumption		200 mW (48V type: 360 mW)				At 20°C
	Operate power consumption		100 mW (48V type: 170 mW)				At 20°C
	Operating temperature range		-40°C ~ +90°C (48V type: +80 °C)				No frost
Timing data	Operate		Max. 6 ms				At nominal voltage (without bounce)
	Release		Max. 3 ms				At nominal voltage (without diode)
Life	Mechanical		Min. 20 x 10 ⁶ operations				
	Electrical		Min. 100 x 10 ³ operations				Contact rating
Insulation	Insulation resistance		Min. 1,000MΩ at 500VDC				Initial
	Dielectric strength	Open contacts	750VAC, 1 minute				
		Coil contact	2,000VAC, 1 minute				
	Surge strength	Coil to contacts	4,000V / 1.2 x 50μs standard wave				
Other	Vibration resistance	Misoperation	10 to 55 to 10Hz single amplitude 0.75 mm				
		Endurance	10 to 55 to 10Hz single amplitude 0.75 mm				
	Shock resistance	Misoperation	Min. 100m/s ² (11 ± 1ms)				
		Endurance	Min. 1,000m/s ² (6 ± 1ms)				
Dimensions / weight		9.8 x 20.0 x 12.8 mm / approx. 5g					
Sealing		Plastic sealed, RTIII					

*: Minimum switching loads mentioned above are reference values. Please perform the confirmation test with actual load before production since reference values may vary according to switching frequencies, environmental conditions and expected reliability levels.

■ Coil Data

Coil code	Rated Coil Voltage (VDC)	Coil Resistance +/-10% (Ω)	Must Operate Voltage* (VDC)	Must Release Voltage* (VDC)	Rated Power (mW)
4.5	4.5	100	3.1	0.23	200
5	5	125	3.5	0.25	
6	6	180	4.2	0.3	
9	9	405	6.3	0.45	
12	12	720	8.4	0.6	
18	18	1,620	12.6	0.9	
24	24	2,880	16.8	1.2	
48	48	6,400	32.6	2.4	360

Note: All values in the table are valid for 20degC and zero contact current unless otherwise specified.

*: Specified operated values are valid for pulse wave voltage.

■ Safety Standards

Type	Compliance	Contact Rating
UL	UL 508	Flammability: UL 94-V0 (plastics)
	E56140	[JY-H, JY-HE] 5A, 250 VAC / 30 VDC (resistive) 1/8 HP, 125VAC, 250 VAC Pilot duty code C150
CSA	C22.2 No. 14 LR 35579	[JY, JY-E] 3A, 250 VAC / 30 VDC (resistive) 1/10 HP, 125VAC, 250 VAC Pilot duty: D150

■ Dimensions

- Dimensions

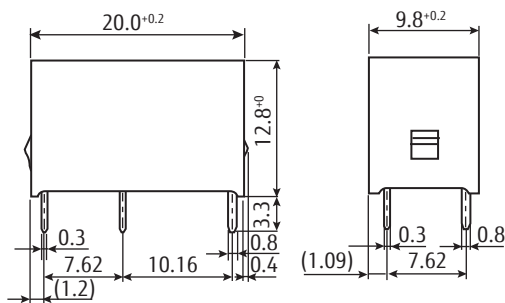

- Schematics
(BOTTOM VIEW)

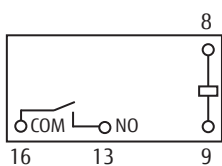

- PC Board Mounting Hole Layout (BOTTOM VIEW)

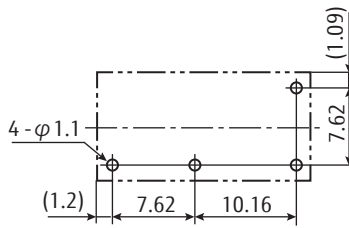

Tolerance of PC board mounting hole layout: ± 0.1 unless otherwise specified.

(): Reference value

Unit: mm

■ Socket Dimensions

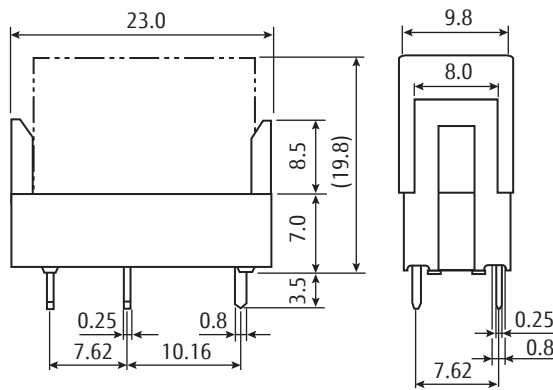

- PC Board Mounting Hole Layout (BOTTOM VIEW)

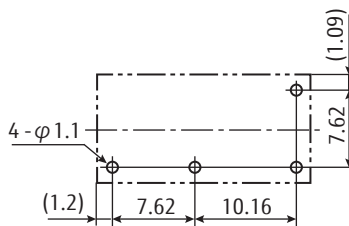

Tolerance of PC board mounting hole layout: ± 0.1 unless otherwise specified.

(): Reference value

Unit: mm

Note:

1: Socket ordering code: JK-4N

2: Standard IC socket is not recommended. Please use socket "JK-4N"

■ Characteristic Data

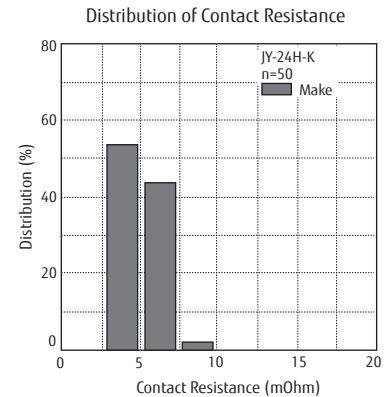
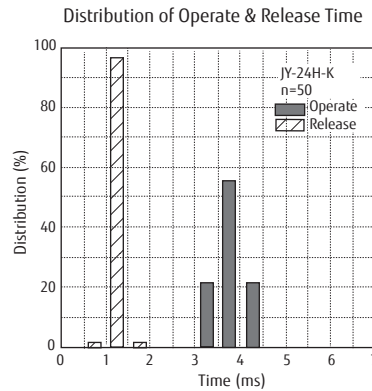
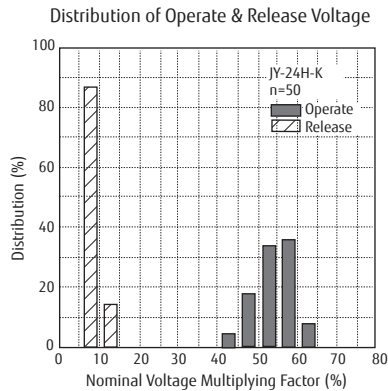
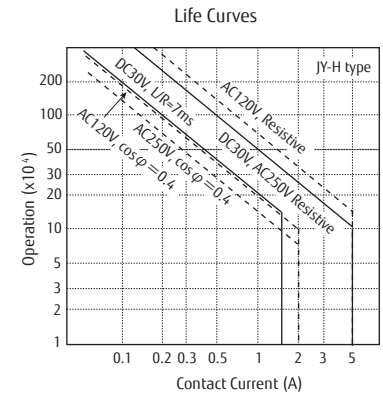
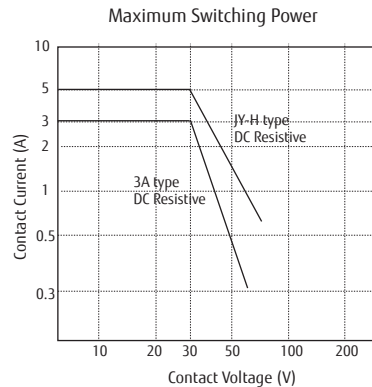
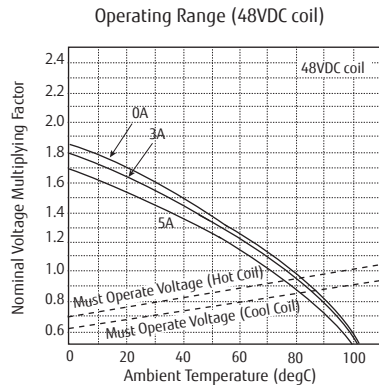
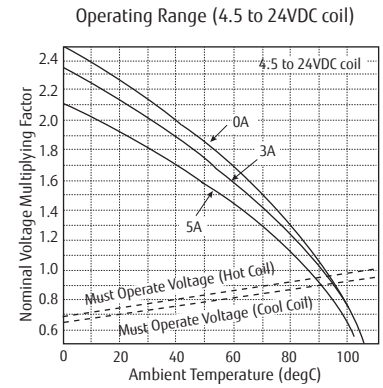
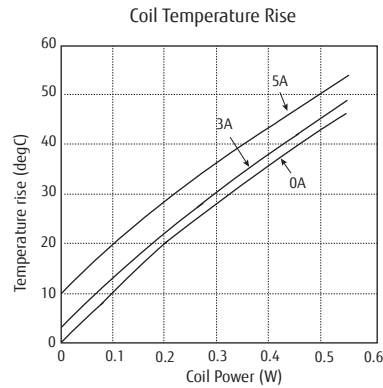
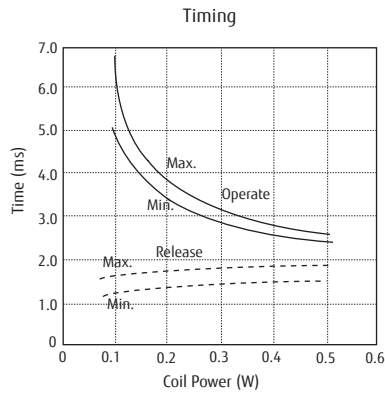

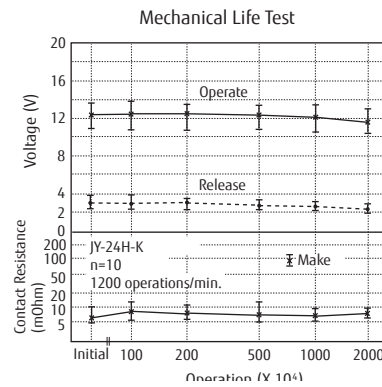
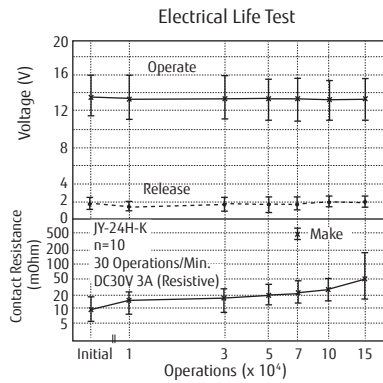
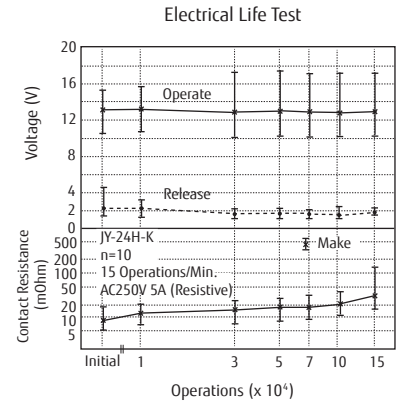
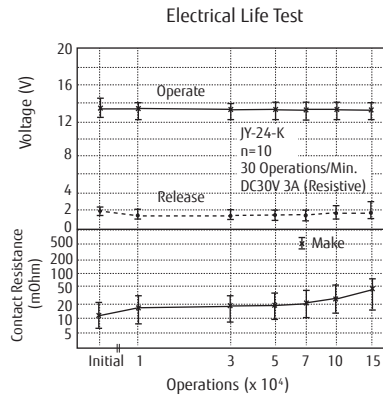
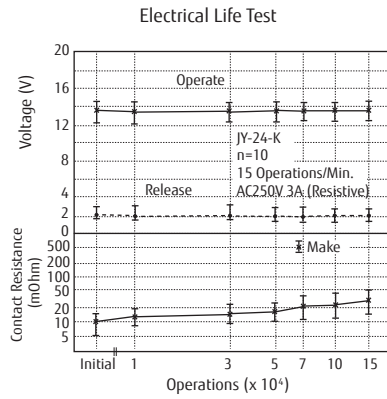

GENERAL INFORMATION

1. ROHS Compliance

- All relays produced by Fujitsu Components are compliant with RoHS directive 2011/65/EU including amendments.
- Use of Cadmium in electrical contacts is exempted as per Annex III of the RoHS directive 2001/65/EU. Please consider expiry date of exemption. Relays with Cadmium containing contacts are not to be used for new designs.
- All relays are lead-free. Please refer to Lead-Free Status Info for older date codes at: <http://www.fujitsu.com/downloads/MICRO/fcai/relays/lead-free-letter.pdf>
- Lead free solder plating on relay terminals is Sn-3.0Ag-0.5Cu, unless otherwise specified. This material has been verified to be compatible with PbSn assembly process.

2. Recommended Lead Free Solder Profile

- Recommended solder for assembly: Sn-3.0Ag-0.5Cu.

Solder by Soldering Iron:

Soldering Iron 30-60W
Temperature: maximum 350-360 °C
Duration: maximum 3 sec.

Flow Solder condition:

Pre-heating: maximum 120 °C
within 90 sec.
Soldering: dip within 5 sec. at
255 °C ± 5 °C solder bath
Relay must be cooled by air immediately
after soldering

We highly recommend that you confirm your actual solder conditions

3. Moisture Sensitivity

- Moisture Sensitivity Level standard is not applicable to electromechanical relays, unless otherwise indicated

4. Tin Whiskers

- Dipped SnAgCu solder is known as presenting a low risk to tin whisker development. No considerable length whisker was found by our in house test.

Fujitsu Components International Headquarter Offices

Japan

FUJITSU COMPONENT LIMITED
Shinagawa Seaside Park Tower 19F,
12-4, Higashi-shinagawa 4-chome, Shinagawa-ku,
Tokyo, 140-0002, Japan
Tel: (81-3) 3450-1682
Fax: (81-3) 3474-2385

North and South America

FUJITSU COMPONENTS AMERICA, INC
2290 North First Street, Suite 212
San Jose, CA 95131, USA
Tel: (1-408) 745-4900
Fax: (1-408) 745-4970

Europe

FUJITSU COMPONENTS EUROPE B.V.
Diamantlaan 25
2132 WV Hoofddorp
Netherlands
Tel: (31-23) 5560910
Fax: (31-23) 5560950

Asia Pacific

FUJITSU COMPONENTS ASIA, LTD.
102E Pasir Panjang Road
#01-01 Citilink Warehouse Complex
Singapore 118529
Tel: (65) 6375-8560
Fax: (65) 6273-3021

China

FUJITSU ELECTRONIC COMPONENTS (SHANGHAI) CO., LTD.
Unit 4306, InterContinental Center
100 Yu Tong Road, Shanghai 200070,
China
Tel: (86-21) 3253 0998
Fax: (86-21) 3253 0997

Hong Kong

FUJITSU COMPONENTS HONG KONG CO., LTD
Unit 506, Inter-Continental Plaza
No.94 Granville Road, Tsim Sha Tsui, Kowloon,
Hong Kong
Tel: (852) 2881-8495
Tex: (852) 2894-9512

Korea

FUJITSU COMPONENTS KOREA LIMITED
Alpha Tower #403, 645 Sampyeong-dong,
Bundang-gu, Seongnam-si, Gyeonggi-do,
13524 Korea
Tel: (82) 31-708-7108
Fax: (82) 31-709-7108

Web: www.fcl.fujitsu.com/en/

©2016 Fujitsu Components Europe B.V. All rights reserved. All trademarks or registered trademarks are the property of their respective owners.

The contents, data and information in this datasheet are provided by Fujitsu Component Ltd. as a service only to its user and only for general information purposes.

The use of the contents, data and information provided in this datasheet is at the users' own risk.

Fujitsu has assembled this datasheet with care and will endeavor to keep the contents, data and information correct, accurate, comprehensive, complete and up to date.

Fujitsu Components Europe B.V. and affiliated companies do however not accept any responsibility or liability on their behalf, nor on behalf of its employees, for any loss or damage, direct, indirect or consequential, with respect to this datasheet, its contents, data, and information and related graphics and the correctness, reliability, accuracy, comprehensiveness, usefulness, availability and completeness thereof.

Nor do Fujitsu Components Europe B.V. and affiliated companies accept on their behalf, nor on behalf of its employees, any responsibility or liability for any representation or warrant of any kind, express or implied, including warranties of any kind for merchantability or fitness for particular use, with respect to these datasheets, its contents, data, information and related graphics and the correctness, reliability, accuracy, comprehensiveness, usefulness, availability and completeness thereof. Rev. Dec 15th, 2016