

# POWER RELAY

## 1 POLE – 20A, 3.0mm contact gap

### FTR-K2G Series

#### ■ FEATURES

- Contact gap min. 3.0mm
- Full disconnection
- 1 Pole, 1 Form A
- Maximum inrush current 120A (TV-8) (UL) (VDE)
- High insulation  
Reinforced insulation  
Insulation distance between coil and contact:
  - Clearance min. 8.0mm, creepage min. 9.5mm
  - Dielectric strength: 5KV
  - Surge strength: 10KV
- Heat resistance, flammability  
Class B (130° C) coil wire class, flammability UL94V-0 (plastic)
- Safety standards  
UL, CSA, VDE approved
- Flux proof type. RT II
- RoHS compliant



#### ■ PARTNUMBER INFORMATION

[Example]    FTR-K2G    A    K    012    T  
                  (a)        (b)    (c)    (d)    (e)

(a)	Relay type	FTR-K2G	: FTR-K2G Series
(b)	Contact configuration	A	: 1 form A
(c)	Coil power	K	: Standard type (1,000mW)
(d)	Coil rated voltage	012	: 5....110VDC See coil data chart
(e)	Contact material / TV type	T	: Silver alloy / TV-8

Actual marking does not carry the type name : "FTR"  
E.g.: Ordering code: FTR-K2GAK012T    Actual marking: K2AK012T

# FTR-K2G Series

## ■ SPECIFICATIONS

Item		FTR-K2GAK( )T		
Contact data	Configuration		1 form A (SPST-NO)	
	Construction		Single	
	Material		Silver alloy	
	Resistance (initial)		Max. 100mΩ at 1A, 6VDC	
	Contact rating (resistive)		20A / 250VAC	
	Max. carrying current *1		25A	
	Max. inrush current		120A / 250VAC	
	Max. switching voltage		400VAC	
	Max. switching power		5,000VA	
	Min. switching load *2		100mA, 5VDC (reference value)	
Coil data	Rated power		Approximately 1,000mW	
	Operate power		Approximately 420mW	
	Operating temperature range		-40°C to +70°C (no frost)	
Timing data	Operate (at nominal voltage)		Max. 30ms (without bounce)	
	Release		Max. 15ms (without bounce)	
Life	Mechanical		Min. 1 x 10 <sup>6</sup> operations	
	Electrical	Resistive	Min. 100 x 10 <sup>3</sup> operations	
		Lamp load (TV-8)	Min. 25 x 10 <sup>3</sup> operations	
Insulation	Resistance (initial)		Min. 1,000MΩ at 500VDC	
	Dielectric strength	Open contacts	2,000VAC (50/60Hz) 1min	
		Coil to contacts	5,000VAC (50/60Hz) 1min	
	Surge strength	Coil to contacts	10,000V / 1.2 x 50μs standard wave	
	Clearance		8 mm	
	Creepage		9.5 mm	
	EN61710-1, VDE0435	Voltage		250V
		Pollution degree		3
		Material group		III a
		Category		B / 250V
Others	Vibration resistance	Misoperation > 1μs	10 to 55 to 10Hz single amplitude 0.75mm	
		Endurance	10 to 55 to 10Hz single amplitude 0.75mm	
	Shock	Misoperation > 1μs	100m/s <sup>2</sup> (11 ± 1ms)	
		Endurance	1,000m/s <sup>2</sup> (6 ± 1ms)	
	Weight		Approximately 34g	
	Sealing		Flux proof (RT II)	

\*1 : Need to consider the heat when mounted on PCB at carry currents > 10A. Please confirm actual condition.

\* 2 : Minimum switching loads mentioned above are reference values. Please perform the confirmation test with actual load before production since reference values may vary according to switching frequencies, environmental conditions and expected reliability levels.

# FTR-K2G Series

## ■ COIL DATA

Coil Code	Rated Coil Voltage (VDC)	Coil Resistance $\pm 10\%$ ( $\Omega$ )	Must Operate Voltage* (VDC)	Must Release Voltage* (VDC)	Rated Power (mW)
005	5	25	3.25	0.25	1,000
006	6	36	3.9	0.3	
009	9	81	5.85	0.45	
012	12	145	7.8	0.6	
018	18	325	11.7	0.9	
022	22	485	14.3	1.1	
024	24	580	15.6	1.2	
048	48	2,200	31.2	2.4	1,050
060	60	3,600	39	3	1,000
110	110	13,000	71.5	5.5	930

Note: All values in the tables are valid for 20°C and zero contact current.

\* Specified operate values are valid for pulse wave voltage.

Please use at rated coil voltage. Please refer to characteristic data and set up adequate voltage in case of use at over voltage.

## ■ COIL DATA

Type	Compliance	Contact rating
UL	UL 508 CSA22.2 No.14 UL/CSA 60950-1 E63614	Flammability: UL 94-V0 (plastics)
		20A, 277VAC (resistive) TV-8, 120 VAC
VDE	IEC/EN61810-1 EN60065 clause 14.6.1 EN60335-1 clause 15.3; 16.3; 29.1; 29.2; 29.3 EN60730-1 clause 12.2; 13.2; 20.1; 20.2; 20.3	20A, 250VAC ( $\cos\phi=1$ ), 70°C 8A/120A, 250VAC, 70°C

# FTR-K2G Series

## ■ DIMENSIONS

Dimensions

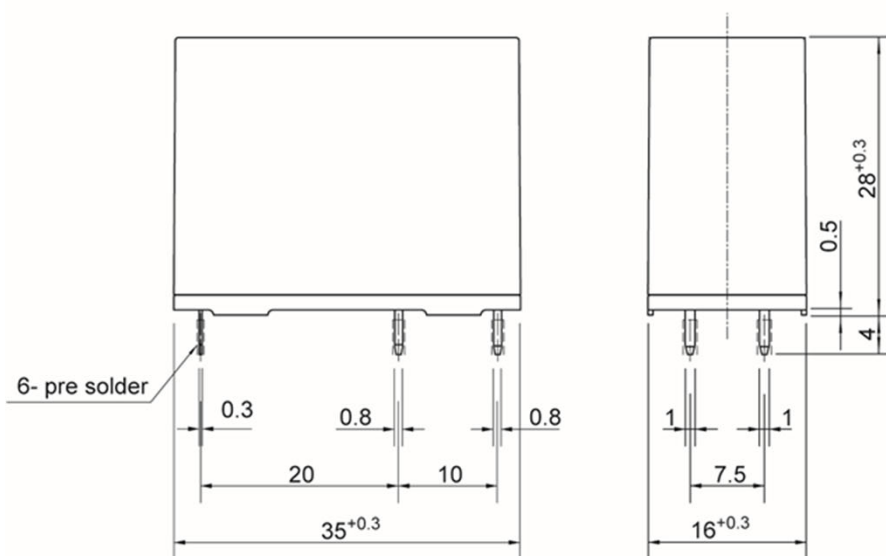

Schematics  
(BOTTOM VIEW)

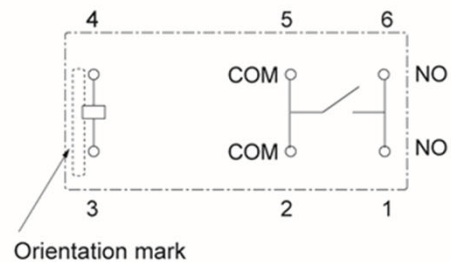

PC board mounting hole layout  
(BOTTOM VIEW)

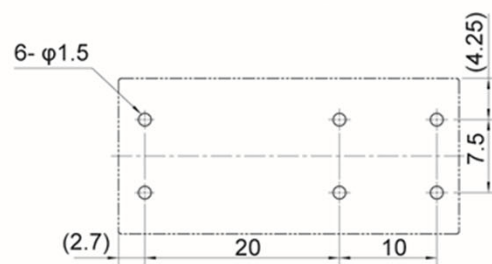

Notes:

- Dimensions of the terminals do not include thickness of pre-solder.
- Dimensions do not include tolerance.
- Tolerance of PC board mounting hole layout :  $\pm 0.1$  unless otherwise specified.

Unit:mm  
( ): Reference

# FTR-K2G Series

## ■ CHARACTERISTIC DATA

(Characteristic data is not guaranteed value but measured values of samples from production line.)

Coil temperature rise

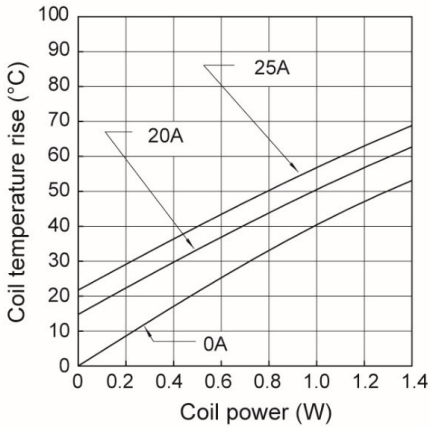

Operating range

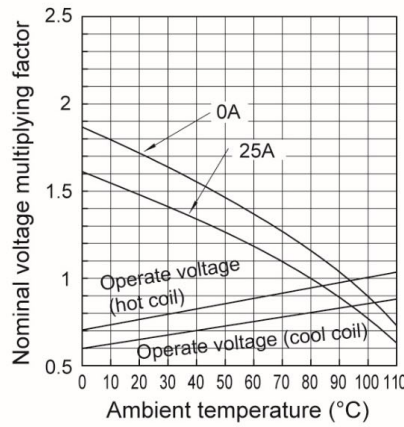

Maximum switching power

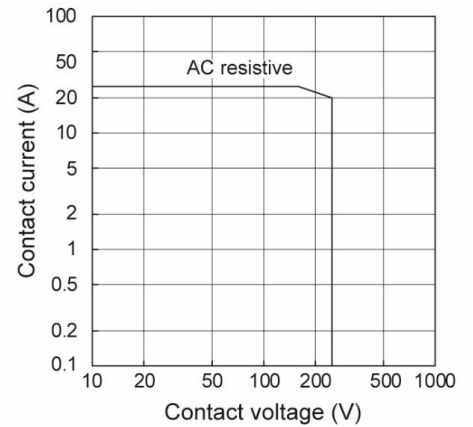

Life curve

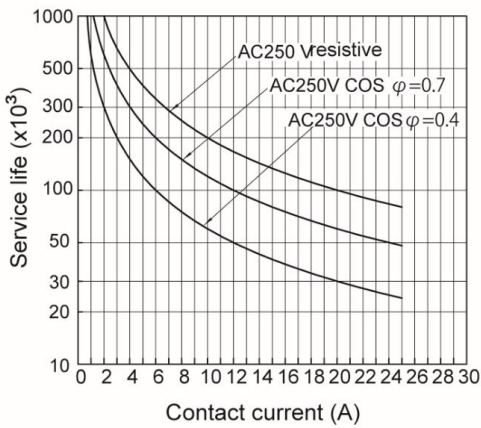

Distribution of operate/release voltage

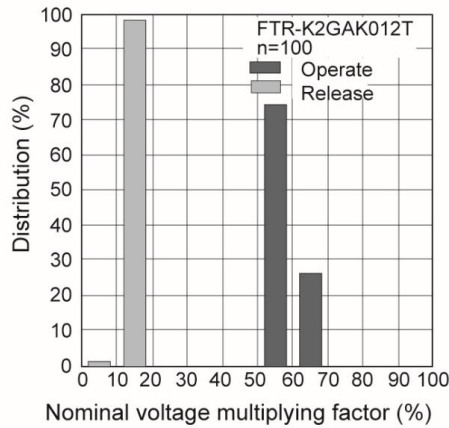

Distribution of operate/release time

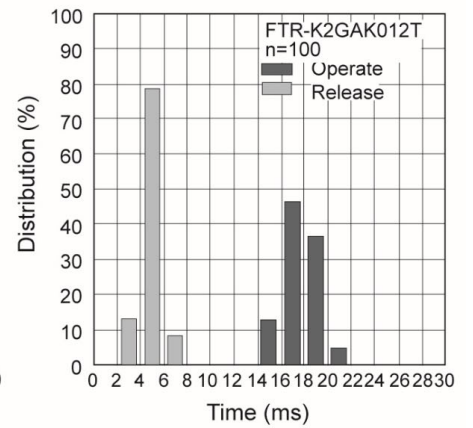

Distribution of contact resistance

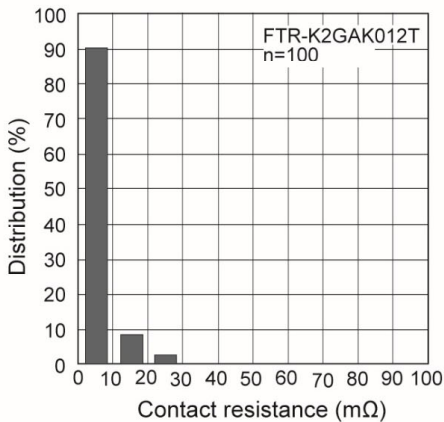

# FTR-K2G Series

## CAUTIONS

- All values mentioned in this datasheet are provided under ideal conditions. Please perform the confirmation test before actual use.
- Reflow soldering is prohibited.
- Do not use relays in the atmosphere with sulfide gas, chloride gas or nitric oxide. Contact resistance may increase.
- Do not use silicon or silicon-containing product or materials near relays. It may cause contact failure.

## GENERAL INFORMATION

### 1. RoHS Compliance

- All relays produced by FCL Components are compliant with RoHS directive 2011/65/EU, including commission delegated directive 2015/863.

### 2. Recommended lead free solder condition

- Lead free solder plating on relay terminals is Sn-3.0Ag-0.5Cu, unless otherwise specified. This material has been verified to be compatible with PbSn assembly process.
- Recommended solder for assembly: Sn-3.0Ag-0.5Cu.

#### Flow Solder Condition:

Pre-Heating: Maximum 120°C within 90 sec.

Soldering: Dip within 5 sec. at 255°C±5°C solder bath

Relay must be cooled by air immediately after soldering

#### Solder by Soldering Iron:

Soldering Iron: 30-60W

Temperature: Maximum 350-360°C

Duration: Maximum 3 sec.

**We highly recommend that you confirm your actual solder conditions**

### 3. Moisture Sensitivity

- Moisture Sensitivity Level standard is not applicable to electromechanical relays, unless otherwise indicated.

### 4. Tin Whiskers

- Dipped SnAgCu solder is known as presenting a low risk to tin whisker development. No considerable length whisker was found by our in house test.

---

## Contact

### Japan

FCL COMPONENTS LIMITED  
Shinagawa Seaside Park Tower  
12-4, Higashi-shinagawa 4-chome,  
Tokyo 140 0002, Japan  
Tel: +81-3-3450-1682  
Email: [fcl-contact@cs.fcl-components.com](mailto:fcl-contact@cs.fcl-components.com)

### North and South America

FCL COMPONENTS AMERICA, INC.  
2055 Gateway Place Suite 480,  
San Jose, CA 95110 USA  
Tel: +1-408-745-4900  
Email: [fcai.components@fcl-components.com](mailto:fcai.components@fcl-components.com)

### Europe

FCL COMPONENTS EUROPE B.V.  
Diamantlaan 25  
2132 WV Hoofddorp, Netherlands  
Tel: +31-23-556-0910  
Email: [info.fceu@cs.fcl-components.com](mailto:info.fceu@cs.fcl-components.com)

### Asia Pacific

FCL COMPONENTS ASIA PTE LTD.  
No. 20 Harbour Drive, #07-01B  
Singapore 117612  
Tel: +65-6375-8560  
Email: [fcalf@fcl-components.com](mailto:fcalf@fcl-components.com)

### China

FCL COMPONENTS (SHANGHAI) CO., LTD.  
Unit 1105, Central Park - Jing An,  
No.329 Heng Feng Road, Shanghai 200070,  
China  
Tel: +86-21-3253 0998  
Email: [fcsh@fcl-components.com](mailto:fcsh@fcl-components.com)

**Web:** [www.fcl-components.com/en/](http://www.fcl-components.com/en/)

---

© 2024 FCL Components Limited. All rights reserved. All trademarks or registered trademarks are the property of their respective owners.

FCL Products are intended for general use, including without limitation, in personal, household and office environments, in buildings and for ordinary use in the industry. FCL Products are not intended to be used in applications where extremely high safety is required ("High Safety Required Applications"), such as, but not limited to, applications in nuclear facilities, in aircraft automatic flight control, in air traffic control, in mass transit system control, in missile launch system, in weapon systems, in medical equipment for life support or any application involving a direct serious risk of physical injury or death.

Please do not use FCL Products without securing the sufficient safety and reliability required for the High Safety Required Applications. In addition, FCL shall not be liable against the customer and/or any third party for any claims or damages arising in connection with the use of FCL Products in the High Safety Required Applications.

FCL warrants that its Products, if properly used and services, will conform to their specification and will be free from defects in material and workmanship for twelve months from delivery.

The implied warranties of merchantability and fitness for a particular purpose and all other warranties, representations and conditions, express or implied by statute, trade usage or otherwise, except as set forth in this warranty, are excluded and shall not apply to the Products delivered.

The contents, data and information in this datasheet are provided by FCL Components Limited as a service only to its user and only for general information purposes. The use of the contents, data and information provided in this datasheet is at the users' own risk.

FCL has assembled this datasheet with care and will endeavor to keep the contents, data and information correct, accurate, comprehensive, complete and up to date.

FCL Components Limited and affiliated companies do however not accept any responsibility or liability on their behalf, nor on behalf of its employees, for any loss or damage, direct, indirect or consequential, with respect to this datasheet, its contents, data, and information and related graphics and the correctness, reliability, accuracy, comprehensiveness, usefulness, availability and completeness thereof.

Nor do FCL Components Limited and affiliated companies accept on their behalf, nor on behalf of its employees, any responsibility or liability with respect to these datasheets, its contents, data, information and related graphics and the correctness, reliability, accuracy, comprehensiveness, usefulness, availability and completeness thereof. Rev. February 1, 2024.

---