

FOR BOARD-TO-BOARD CONNECTION

240 SERIES (LOW-PROFILE STACKING)

■ FEATURES

- The connectors can connect boards in parallel (stacking) at intervals of 8 mm (0.31 in.) to 14 mm (0.55 in.) for various applications.
- Connectors with ten different numbers of contacts are available for various purposes: 20 to 100 in steps of ten and 120.
- Connectors are surface mount compatible.
- 1.27 mm (0.050 in.) pitch contact arrangement in two rows enables high-density mounting. Tails are spaced in a four-row staggered arrangement (2.54 mm × 1.905 mm) (0.100 in. × 0.075 in.) for easy patterning on PC boards.
- Bellows contacts ensure stable contact preventing pins from bending. The bellows contacts also have excellent stability with repeated insertion and extraction.

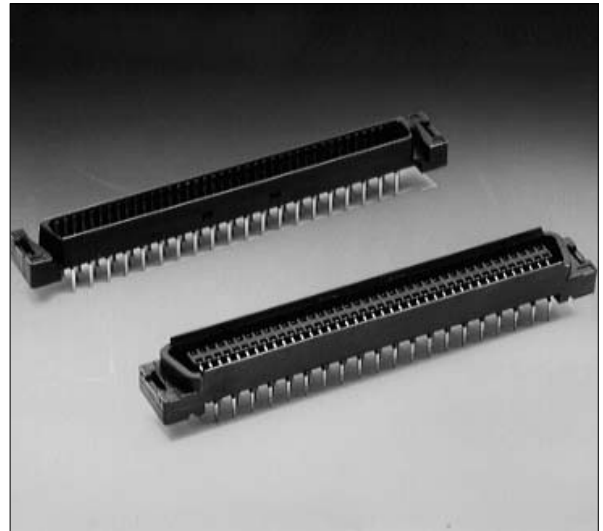

■ SPECIFICATIONS

Item	Specifications
Operating temperature range	-55°C to +105°C
Current rating	DC 1 A
Voltage rating	AC 250 V
Contact resistance	35 mΩ max. (DC 6 V, 0.1 A)
Insulation resistance	1000 MΩ min. (DC 500 V)
Dielectric withstand voltage	AC 750 V for 1 minute

■ MATERIALS

Item	Materials	
Insulator	Polyamide resin (94V-0)	
Conductor	Copper alloy	
Plating	Contact	Gold plating (PAGOS)
	Terminal	Palladium plating

240 Series (Low-Profile Stacking)

■ STACKING SPECIFICATIONS

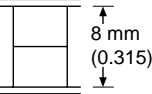
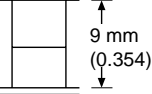
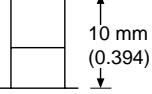
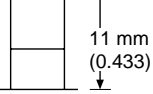
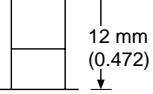
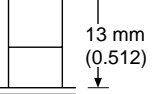
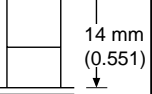
Board interval (mm (in.))		8	9	10	11*	12	13	14
Mounting dimensions		 8 mm (0.315)	 9 mm (0.354)	 10 mm (0.394)	 11 mm (0.433)	 12 mm (0.472)	 13 mm (0.512)	 14 mm (0.551)
Part number	Plug	FCN-244Mxxx-G/0 Note: This plug is used for all dimensions. (Plug with a board lock: FCN-244Mxxx-G/A)						
	Socket	FCN-244Fxxx-G/0 FCN-244Fxxx-G/A	FCN-244Fxxx-G/1 FCN-244Fxxx-G/B	FCN-244Fxxx-G/2 FCN-244Fxxx-G/C	FCN-244Fxxx-G/3 FCN-244Fxxx-G/D	FCN-244Fxxx-G/4 FCN-244Fxxx-G/E	FCN-244Fxxx-G/5 FCN-244Fxxx-G/F	FCN-244Fxxx-G/6 FCN-244Fxxx-G/G

240 Series (Low-Profile Stacking)

STRAIGHT PLUG

■ DIMENSIONS

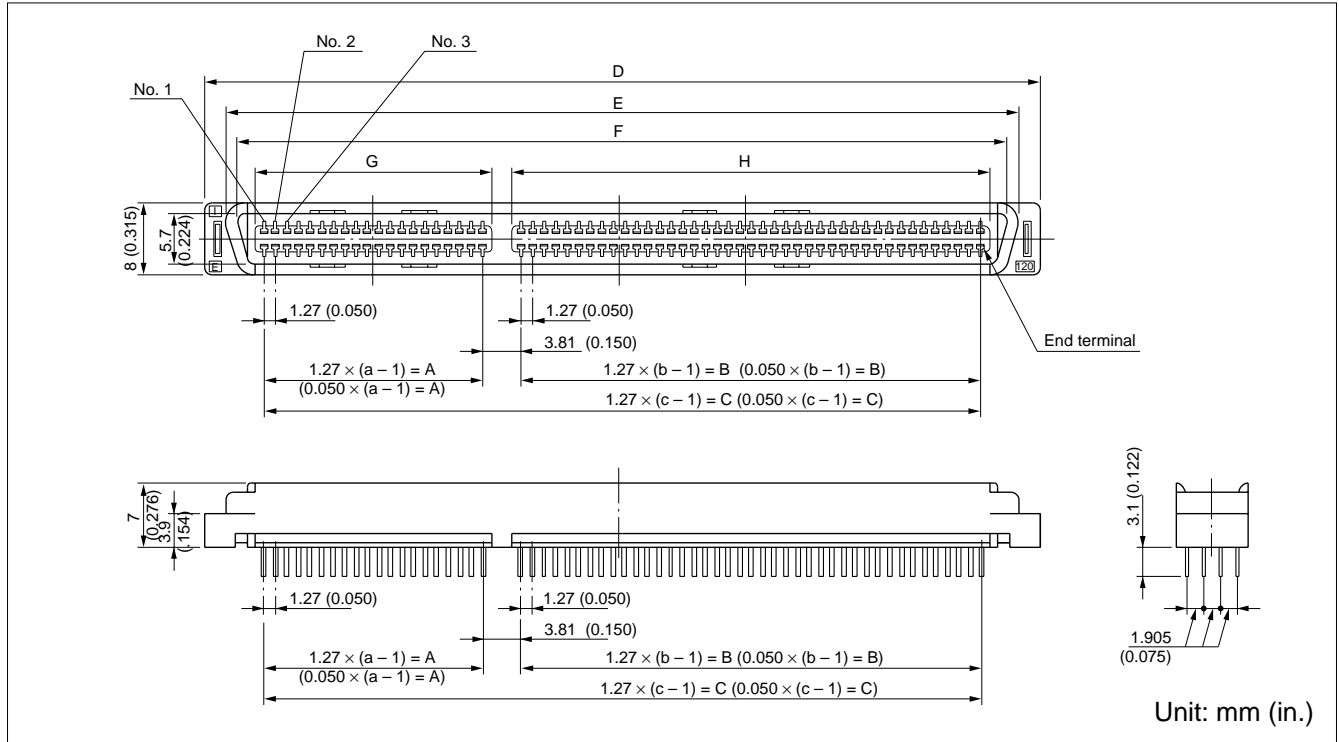

■ MOUNTING HOLE LAYOUT (COMPONENT SIDE)

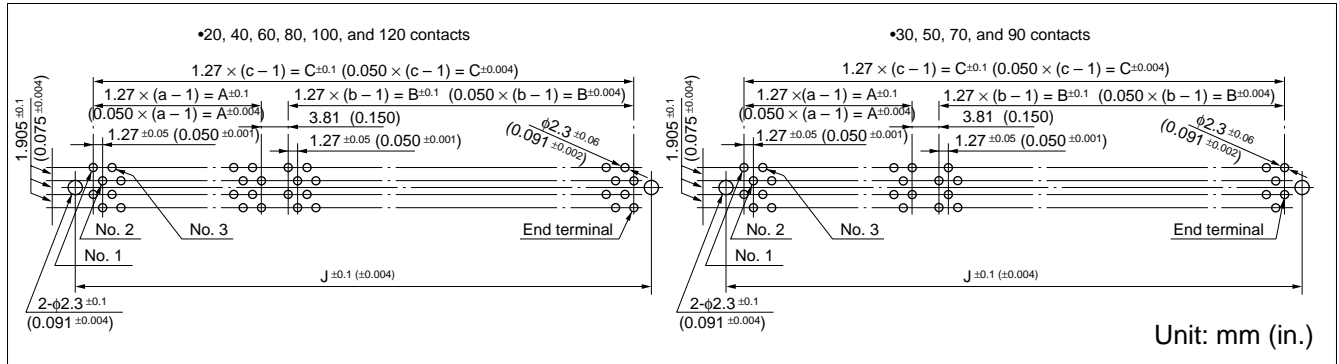

Connectors without a board lock do not require the mounting holes of 2-φ2.3 mm (0.091 in.) at both ends.

■ PART NUMBERS AND DIMENSIONS

Number of contacts	Part number	Dimensions: mm (in.)											
		a	A	b	B	c	C	D	E	F	G	H	J
20	FCN-244M020-G/0	—	—	—	—	10(0.394)	11.43(0.450)	24.05(0.947)	19.27(0.759)	17.27(0.679)	13.43(0.680)	—	21.40(0.843)
30	FCN-244M030-G/0	—	—	—	—	15(0.591)	17.78(0.700)	30.40(1.197)	25.62(1.009)	23.62(0.929)	19.78(0.930)	—	27.75(1.093)
40	FCN-244M040-G/0	—	—	—	—	20(0.787)	24.13(0.950)	36.75(1.447)	31.97(1.259)	29.97(1.179)	26.13(1.180)	—	34.10(1.343)
50	FCN-244M050-G/0	—	—	—	—	25(0.984)	30.48(1.200)	43.10(1.697)	38.32(1.509)	36.32(1.429)	32.48(1.430)	—	40.45(1.593)
60	FCN-244M060-G/0	—	—	—	—	30(1.181)	36.83(1.450)	49.45(1.947)	44.67(1.759)	42.67(1.679)	38.83(1.680)	—	46.80(1.845)
70	FCN-244M070-G/0	—	—	—	—	35(1.378)	43.18(1.700)	55.80(2.197)	51.02(2.009)	49.02(1.929)	45.18(1.930)	—	53.15(2.093)
80	FCN-244M080-G/0	—	—	—	—	40(1.575)	49.53(1.950)	62.15(2.447)	57.37(2.259)	55.37(2.179)	51.53(2.180)	—	59.50(2.343)
90	FCN-244M090-G/0	—	—	—	—	45(1.772)	55.88(2.200)	68.50(2.697)	63.15(2.517)	61.62(2.425)	57.88(2.426)	—	65.85(2.593)
100	FCN-244M100-G/0	—	—	—	—	50(1.969)	62.23(2.450)	74.85(2.947)	70.07(2.759)	68.07(2.679)	64.23(2.680)	—	72.20(2.843)
120	FCN-244M120-G/0	20(0.787)	24.13(0.950)	40(1.575)	49.53(1.950)	—	77.47(3.050)	90.09(3.547)	85.31(3.359)	83.31(3.279)	25.93(3.280)	51.33(2.021)	87.44(3.443)

Connectors with board lock brackets are also available. Specify a part number by replacing -G/0 at the end with -G/A.

240 Series (Low-Profile Stacking)

STRAIGHT SOCKET [FOR BOARD INTERVAL OF 8 MM (0.315 IN.)] ■ DIMENSIONS

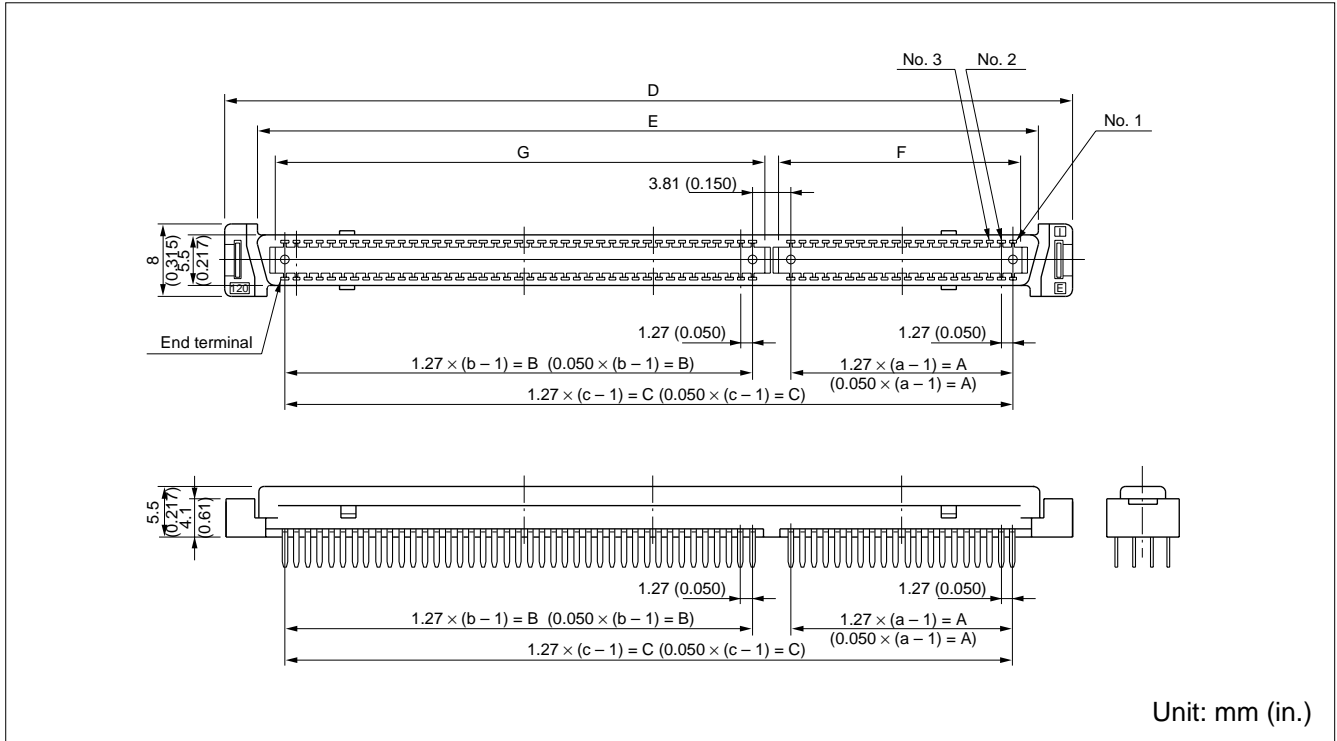

■ MOUNTING HOLE LAYOUT (COMPONENT SIDE)

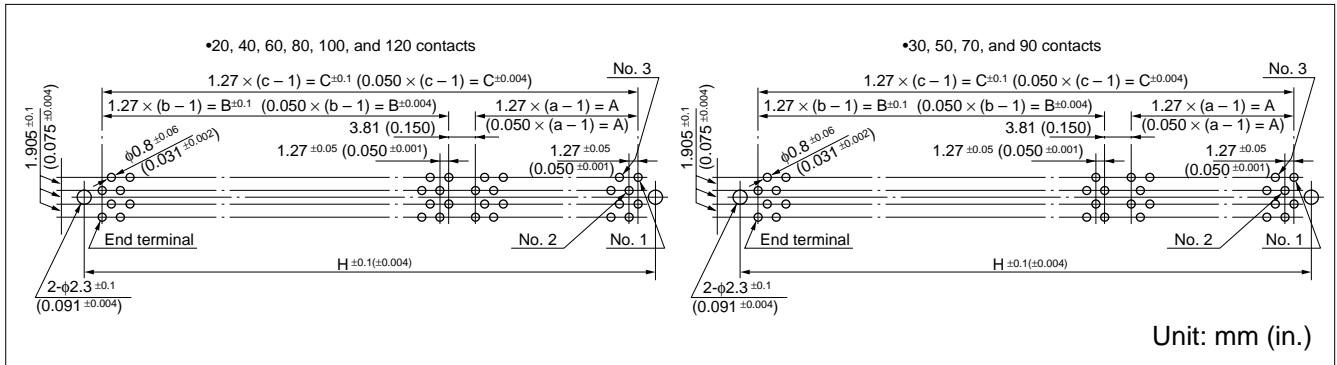

Connectors without a board lock do not require the mounting holes of 2-φ2.3 mm (0.091 in.) at both ends.

■ PART NUMBERS AND DIMENSIONS

Number of contacts	Part number	Dimensions: mm (in.)										
		a	A	b	B	c	C	D	E	F	G	H
20	FCN-244F020-G/0	—	—	—	—	10(0.394)	11.43(0.450)	24.05(0.947)	16.77(0.759)	13.43(0.680)	—	21.40(0.843)
30	FCN-244F030-G/0	—	—	—	—	15(0.591)	17.78(0.700)	30.40(1.197)	23.12(1.009)	19.78(0.930)	—	27.75(1.093)
40	FCN-244F040-G/0	—	—	—	—	20(0.787)	24.13(0.950)	36.75(1.447)	29.47(1.259)	26.13(1.180)	—	34.10(1.343)
50	FCN-244F050-G/0	—	—	—	—	25(0.984)	30.48(1.200)	43.10(1.697)	35.82(1.509)	32.48(1.430)	—	40.45(1.593)
60	FCN-244F060-G/0	—	—	—	—	30(1.181)	36.83(1.450)	49.45(1.947)	42.17(1.759)	38.83(1.680)	—	46.80(1.845)
70	FCN-244F070-G/0	—	—	—	—	35(1.378)	43.18(1.700)	55.80(2.197)	48.52(2.009)	45.18(1.930)	—	53.15(2.093)
80	FCN-244F080-G/0	—	—	—	—	40(1.575)	49.53(1.950)	62.15(2.447)	54.87(2.259)	51.53(2.180)	—	59.50(2.343)
90	FCN-244F090-G/0	—	—	—	—	45(1.772)	55.88(2.200)	68.50(2.697)	61.22(2.759)	57.88(2.426)	—	65.85(2.593)
100	FCN-244F100-G/0	—	—	—	—	50(1.969)	62.23(2.450)	74.85(2.947)	67.57(2.759)	64.23(2.680)	—	72.20(2.843)
120	FCN-244F120-G/0	20(0.787)	24.13(0.950)	40(1.575)	49.53(1.950)	—	77.47(3.050)	90.09(3.547)	82.81(3.359)	25.93(3.280)	51.53(2.021)	87.44(3.443)

Connectors with board lock brackets are also available. Specify a part number by replacing -G/0 at the end with -G/A.

240 Series (Low-Profile Stacking)

STRAIGHT SOCKET [FOR BOARD INTERVAL OF 9 MM (0.354 IN.)]

■ DIMENSIONS

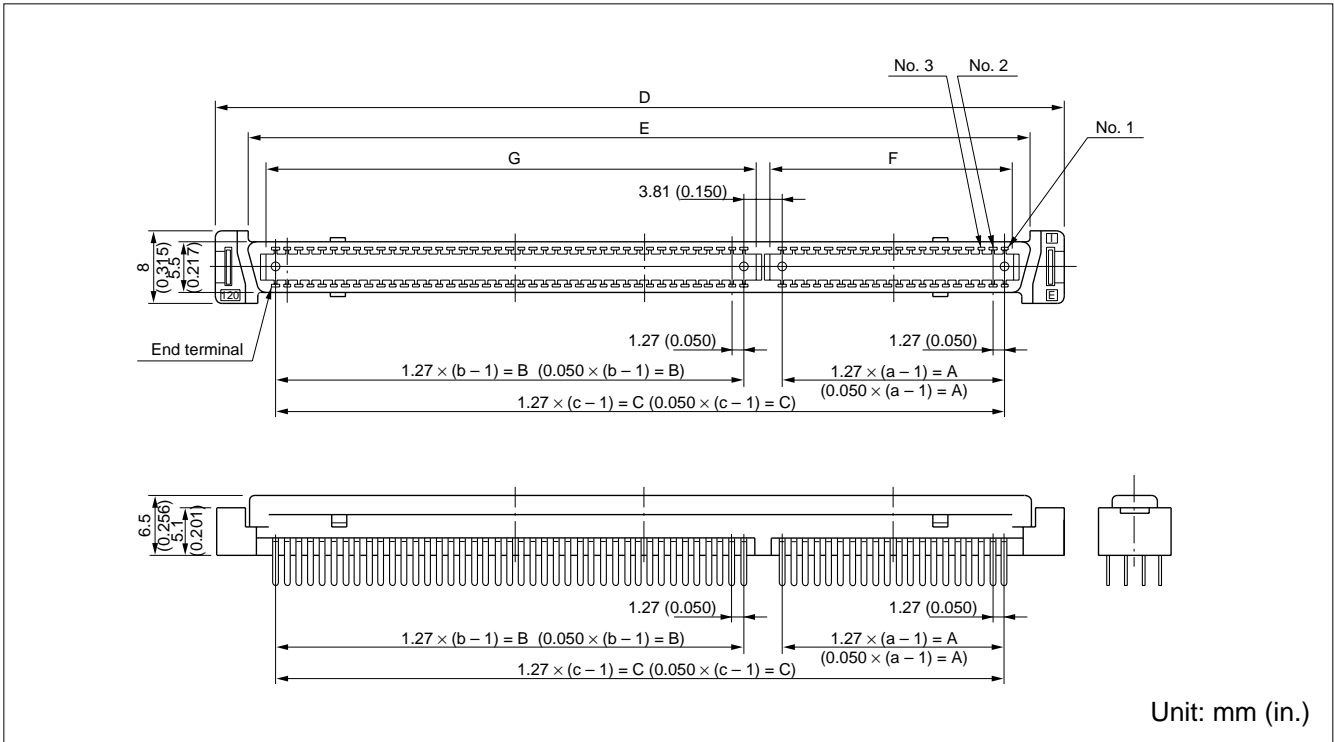

■ MOUNTING HOLE LAYOUT (COMPONENT SIDE)

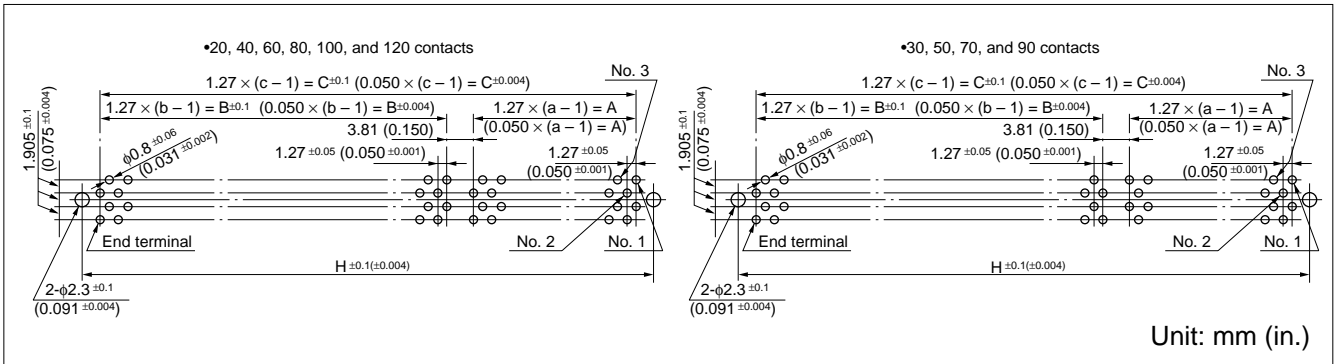

Connectors without a board lock do not require the mounting holes of 2-φ2.3 mm (0.091 in.) at both ends.

■ PART NUMBERS AND DIMENSIONS

Number of contacts	Part number	Dimensions: mm (in.)										
		a	A	b	B	c	C	D	E	F	G	H
20	FCN-244F020-G/1	—	—	—	—	10(0.394)	11.43(0.450)	24.05(0.947)	16.77(0.759)	13.43(0.680)	—	21.40(0.843)
30	FCN-244F030-G/1	—	—	—	—	15(0.591)	17.78(0.700)	30.40(1.197)	23.12(1.009)	19.78(0.930)	—	27.75(1.093)
40	FCN-244F040-G/1	—	—	—	—	20(0.787)	24.13(0.950)	36.75(1.447)	29.47(1.259)	26.13(1.180)	—	34.10(1.343)
50	FCN-244F050-G/1	—	—	—	—	25(0.984)	30.48(1.200)	43.10(1.697)	35.82(1.509)	32.48(1.430)	—	40.45(1.593)
60	FCN-244F060-G/1	—	—	—	—	30(1.181)	36.83(1.450)	49.45(1.947)	42.17(1.759)	38.83(1.680)	—	46.80(1.845)
70	FCN-244F070-G/1	—	—	—	—	35(1.378)	43.18(1.700)	55.80(2.197)	48.52(2.009)	45.18(1.930)	—	53.15(2.093)
80	FCN-244F080-G/1	—	—	—	—	40(1.575)	49.53(1.950)	62.15(2.447)	54.87(2.259)	51.53(2.180)	—	59.50(2.343)
90	FCN-244F090-G/1	—	—	—	—	45(1.772)	55.88(2.200)	68.50(2.697)	61.22(2.759)	57.88(2.426)	—	65.85(2.593)
100	FCN-244F100-G/1	—	—	—	—	50(1.969)	62.23(2.450)	74.85(2.947)	67.57(2.759)	64.23(2.680)	—	72.20(2.843)
120	FCN-244F120-G/1	20(0.787)	24.13(0.950)	40(1.575)	49.53(1.950)	—	77.47(3.050)	90.09(3.547)	82.81(3.359)	25.93(3.280)	51.53(2.021)	87.44(3.443)

Connectors with board lock brackets are also available. Specify a part number by replacing -G/1 at the end with -G/B.

240 Series (Low-Profile Stacking)

STRAIGHT SOCKET [FOR BOARD INTERVAL OF 11 MM (0.433 IN.)]

■ DIMENSIONS

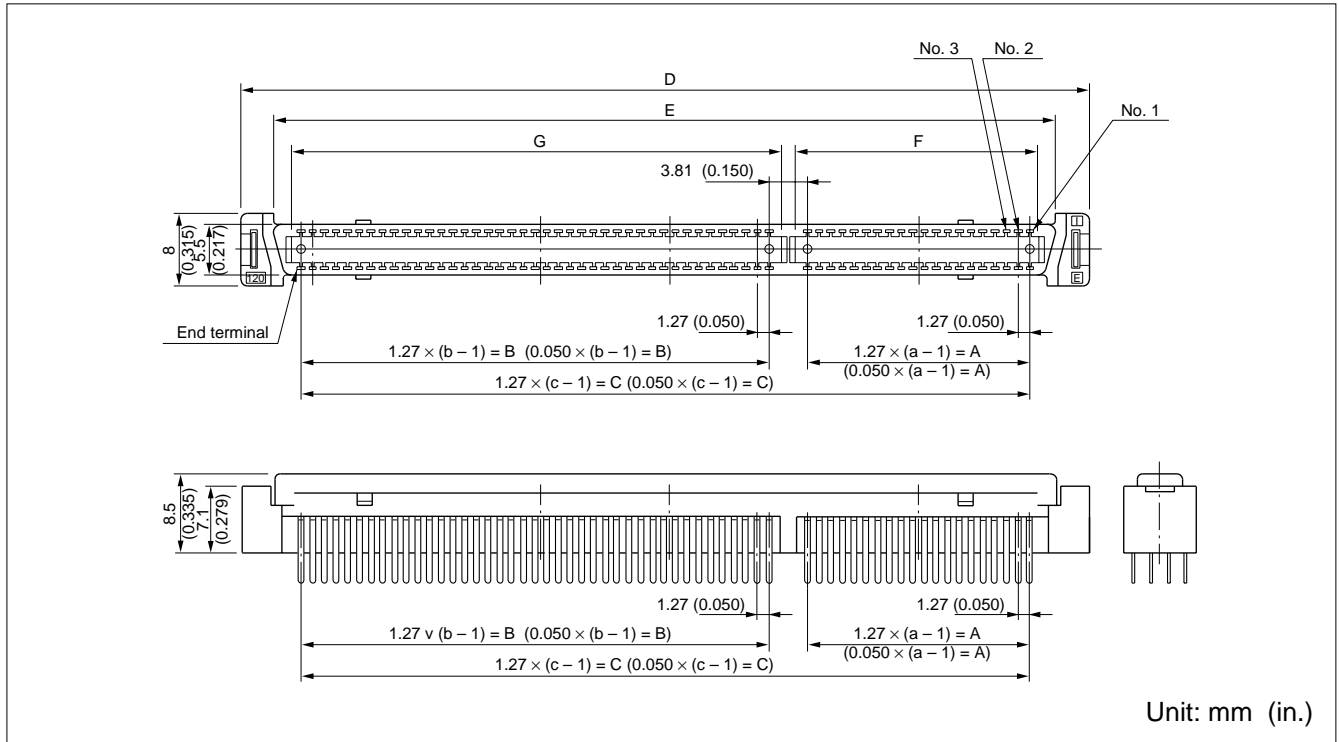

■ MOUNTING HOLE LAYOUT (COMPONENT SIDE)

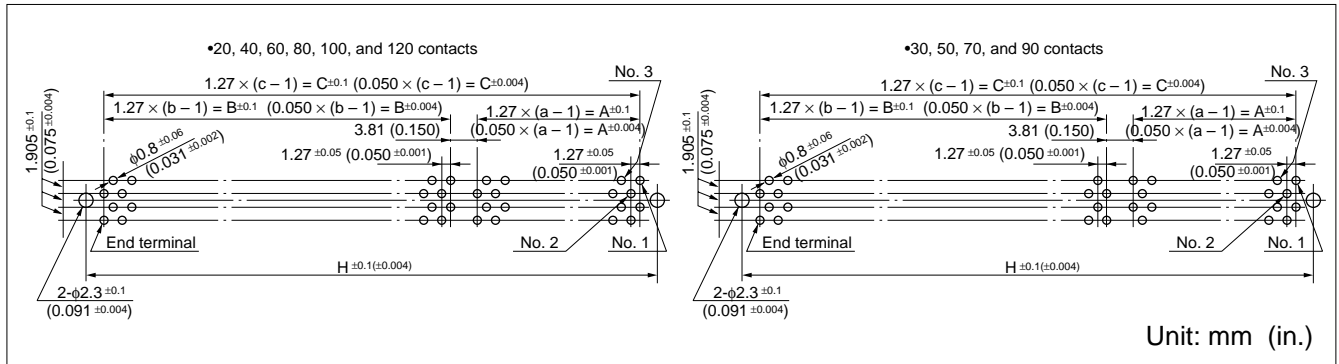

Connectors without a board lock do not require the mounting holes of 2-φ2.3 mm (0.091 in.) at both ends.

■ PART NUMBERS AND DIMENSIONS

Number of contacts	Part number	Dimensions: mm (in.)										
		a	A	b	B	c	C	D	E	F	G	H
20	FCN-244F020-G/3	—	—	—	—	10(0.394)	11.43(0.450)	24.05(0.947)	16.77(0.759)	13.43(0.680)	—	21.40(0.843)
30	FCN-244F030-G/3	—	—	—	—	15(0.591)	17.78(0.700)	30.40(1.197)	23.12(1.009)	19.78(0.930)	—	27.75(1.093)
40	FCN-244F040-G/3	—	—	—	—	20(0.787)	24.13(0.950)	36.75(1.447)	29.47(1.259)	26.13(1.180)	—	34.10(1.343)
50	FCN-244F050-G/3	—	—	—	—	25(0.984)	30.48(1.200)	43.10(1.697)	35.82(1.509)	32.48(1.430)	—	40.45(1.593)
60	FCN-244F060-G/3	—	—	—	—	30(1.181)	36.83(1.450)	49.45(1.947)	42.17(1.759)	38.83(1.680)	—	46.80(1.845)
70	FCN-244F070-G/3	—	—	—	—	35(1.378)	43.18(1.700)	55.80(2.197)	48.52(2.009)	45.18(1.930)	—	53.15(2.093)
80	FCN-244F080-G/3	—	—	—	—	40(1.575)	49.53(1.950)	62.15(2.447)	54.87(2.259)	51.53(2.180)	—	59.50(2.343)
90	FCN-244F090-G/3	—	—	—	—	45(1.772)	55.88(2.200)	68.50(2.697)	61.22(2.759)	57.88(2.426)	—	65.85(2.593)
100	FCN-244F100-G/3	—	—	—	—	50(1.969)	62.23(2.450)	74.85(2.947)	67.57(2.759)	64.23(2.680)	—	72.20(2.843)
120	FCN-244F120-G/3	20(0.787)	24.13(0.950)	40(1.575)	49.53(1.950)	—	77.47(3.050)	90.09(3.547)	82.81(3.359)	25.93(2.280)	51.53(2.021)	87.44(3.443)

Connectors with board lock brackets are also available. Specify a part number by replacing -G/3 at the end with -G/D.

240 Series (Low-Profile Stacking)

STRAIGHT SOCKET [FOR BOARD INTERVAL OF 12 MM (0.472 IN.)]

■ DIMENSIONS

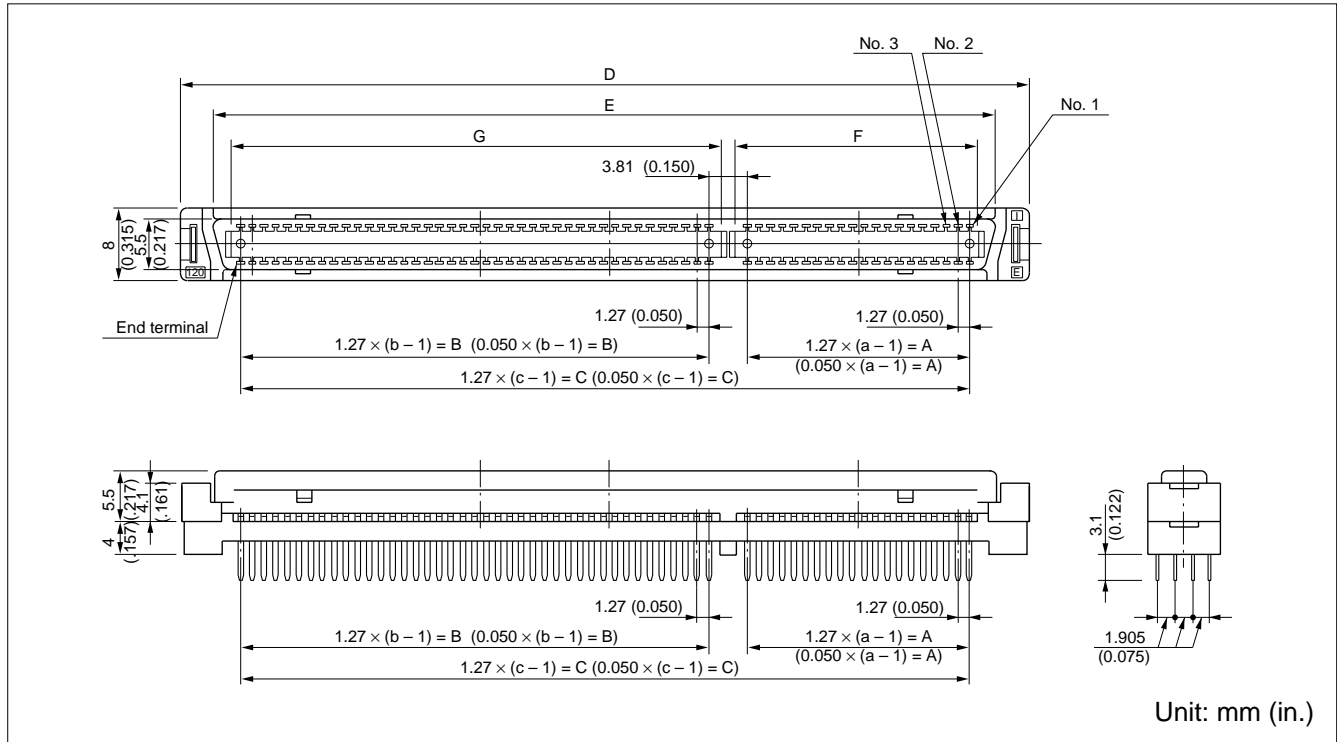

■ MOUNTING HOLE LAYOUT (COMPONENT SIDE)

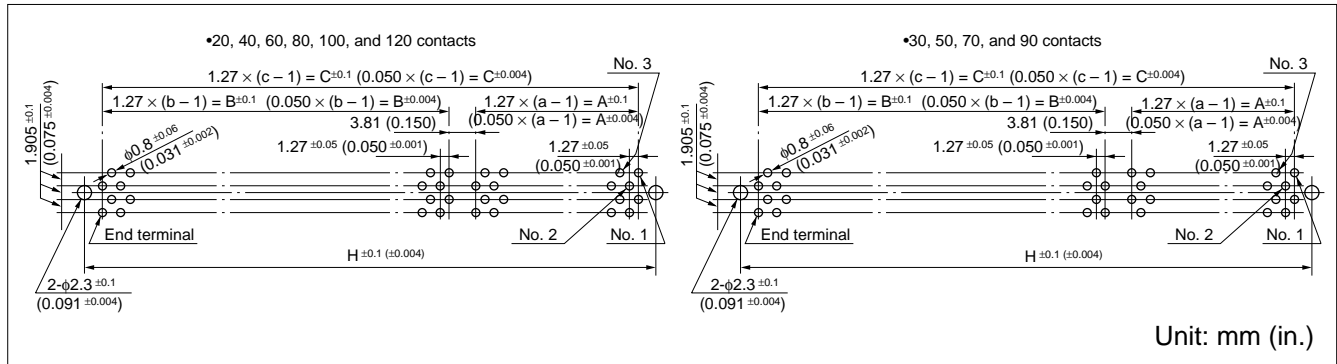

Connectors without a board lock do not require the mounting holes of 2-φ2.3 mm (0.091 in.) at both ends.

■ PART NUMBERS AND DIMENSIONS

Number of contacts	Part number	Dimensions: mm (in.)										
		a	A	b	B	c	C	D	E	F	G	H
20	FCN-244F020-G/4	—	—	—	—	10(0.394)	11.43(0.450)	24.05(0.947)	16.77(0.759)	13.43(0.680)	—	1.40(0.843)
30	FCN-244F030-G/4	—	—	—	—	15(0.591)	17.78(0.700)	30.40(1.197)	23.12(1.009)	19.78(0.930)	—	27.75(1.093)
40	FCN-244F040-G/4	—	—	—	—	20(0.787)	24.13(0.950)	36.75(1.447)	29.47(1.259)	26.13(1.180)	—	34.10(1.343)
50	FCN-244F050-G/4	—	—	—	—	25(0.984)	30.48(1.200)	43.10(1.697)	35.82(1.509)	32.48(1.430)	—	40.45(1.593)
60	FCN-244F060-G/4	—	—	—	—	30(1.181)	36.83(1.450)	49.45(1.947)	42.17(1.759)	38.83(1.680)	—	46.80(1.845)
70	FCN-244F070-G/4	—	—	—	—	35(1.378)	43.18(1.700)	55.80(2.197)	48.52(2.009)	45.18(1.930)	—	53.15(2.093)
80	FCN-244F080-G/4	—	—	—	—	40(1.575)	49.53(1.950)	62.15(2.447)	54.87(2.259)	51.53(2.180)	—	59.50(2.343)
90	FCN-244F090-G/4	—	—	—	—	45(1.772)	55.88(2.200)	68.50(2.697)	61.22(2.759)	57.88(2.426)	—	65.85(2.593)
100	FCN-244F100-G/4	—	—	—	—	50(1.969)	62.23(2.450)	74.85(2.947)	67.57(2.759)	64.23(2.680)	—	72.20(2.843)
120	FCN-244F120-G/4	20(0.787)	24.13(0.950)	40(1.575)	49.53(1.950)	—	77.47(3.050)	90.09(3.547)	82.81(3.359)	25.93(3.280)	51.53(2.021)	87.44(3.443)

Connectors with board lock brackets are also available. Specify a part number by replacing -G/4 at the end with -G/E.

240 Series (Low-Profile Stacking)

STRAIGHT SOCKET [FOR BOARD INTERVAL OF 13 MM (0.512 IN.)]

■ DIMENSIONS

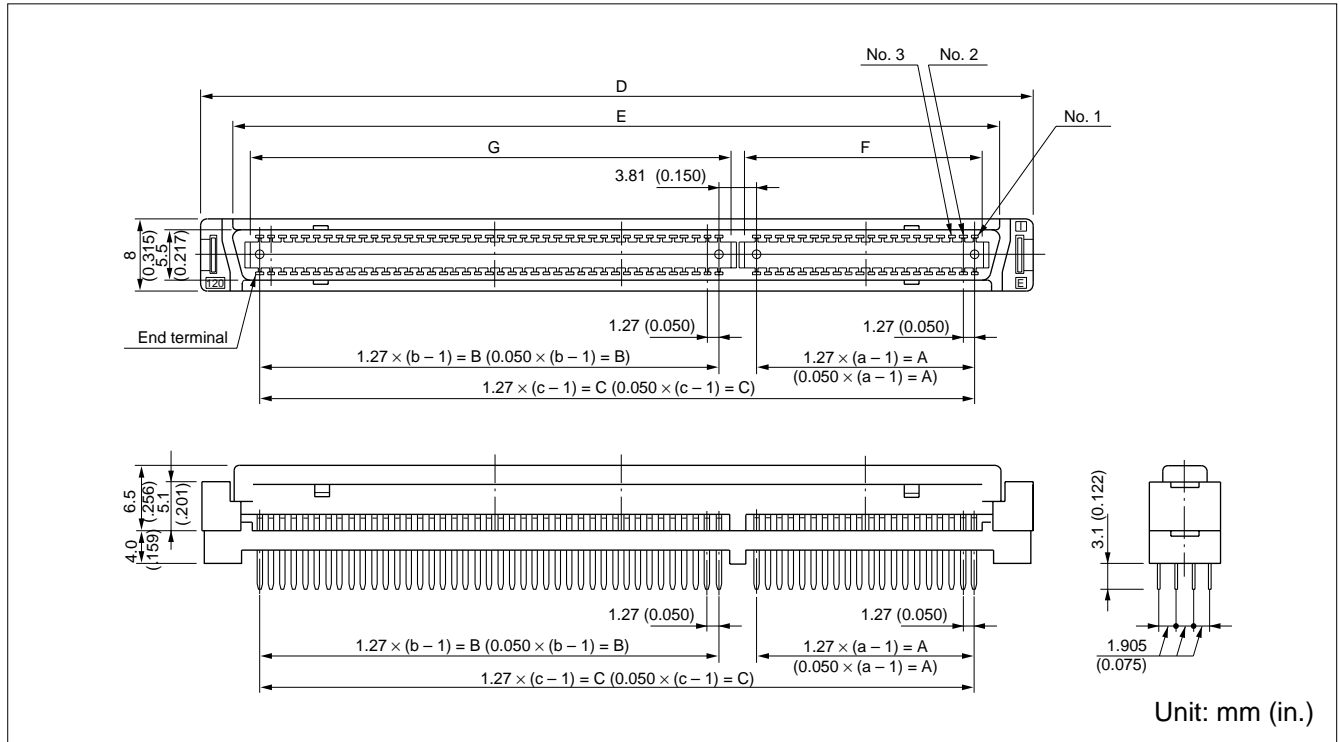

■ MOUNTING HOLE LAYOUT (COMPONENT SIDE)

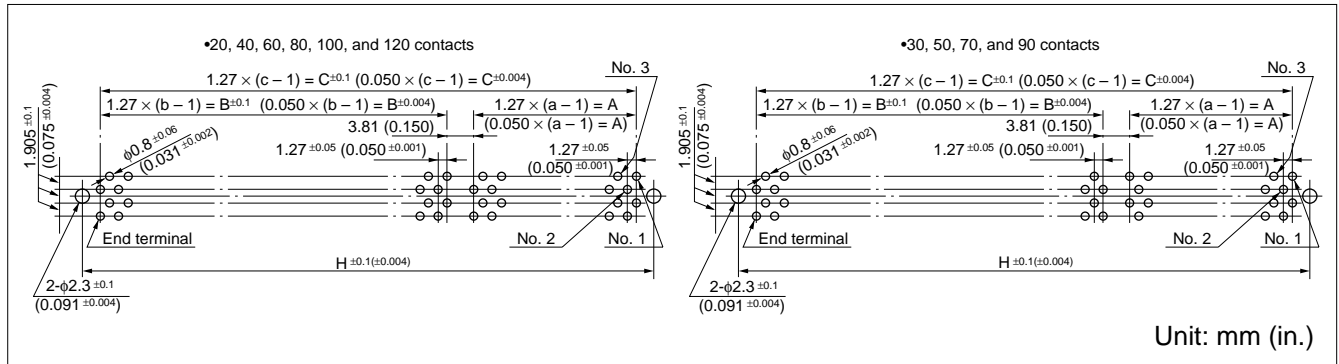

Connectors without a board lock do not require the mounting holes of 2-φ2.3 mm (0.091 in.) at both ends.

■ PART NUMBERS AND DIMENSIONS

Number of contacts	Part number	Dimensions: mm (in.)										
		a	A	b	B	c	C	D	E	F	G	H
20	FCN-244F020-G/5	—	—	—	—	10(0.394)	11.43(0.450)	24.05(0.947)	16.77(0.759)	13.43(0.680)	—	1.40(0.843)
30	FCN-244F030-G/5	—	—	—	—	15(0.591)	17.78(0.700)	30.40(1.197)	23.12(1.009)	19.78(0.930)	—	27.75(1.093)
40	FCN-244F040-G/5	—	—	—	—	20(0.787)	24.13(0.950)	36.75(1.447)	29.47(1.259)	26.13(1.180)	—	34.10(1.343)
50	FCN-244F050-G/5	—	—	—	—	25(0.984)	30.48(1.200)	43.10(1.697)	35.82(1.509)	32.48(1.430)	—	40.45(1.593)
60	FCN-244F060-G/5	—	—	—	—	30(1.181)	36.83(1.450)	49.45(1.947)	42.17(1.759)	38.83(1.680)	—	46.80(1.845)
70	FCN-244F070-G/5	—	—	—	—	35(1.378)	43.18(1.700)	55.80(2.197)	48.52(2.009)	45.18(1.930)	—	53.15(2.093)
80	FCN-244F080-G/5	—	—	—	—	40(1.575)	49.53(1.950)	62.15(2.447)	54.87(2.259)	51.53(2.180)	—	59.50(2.343)
90	FCN-244F090-G/5	—	—	—	—	45(1.772)	55.88(2.200)	68.50(2.697)	61.22(2.759)	57.88(2.426)	—	65.85(2.593)
100	FCN-244F100-G/5	—	—	—	—	50(1.969)	62.23(2.450)	74.85(2.947)	67.57(2.759)	64.23(2.680)	—	72.20(2.843)
120	FCN-244F120-G/5	20(0.787)	24.13(0.950)	40(1.575)	49.53(1.950)	—	77.47(3.050)	90.09(3.547)	82.81(3.359)	25.93(2.280)	51.53(2.021)	87.44(3.443)

Connectors with board lock brackets are also available. Specify a part number by replacing -G/5 at the end with -G/F.

240 Series (Low-Profile Stacking)

STRAIGHT SOCKET [FOR BOARD INTERVAL OF 14 MM (0.552 IN.)]

■ DIMENSIONS

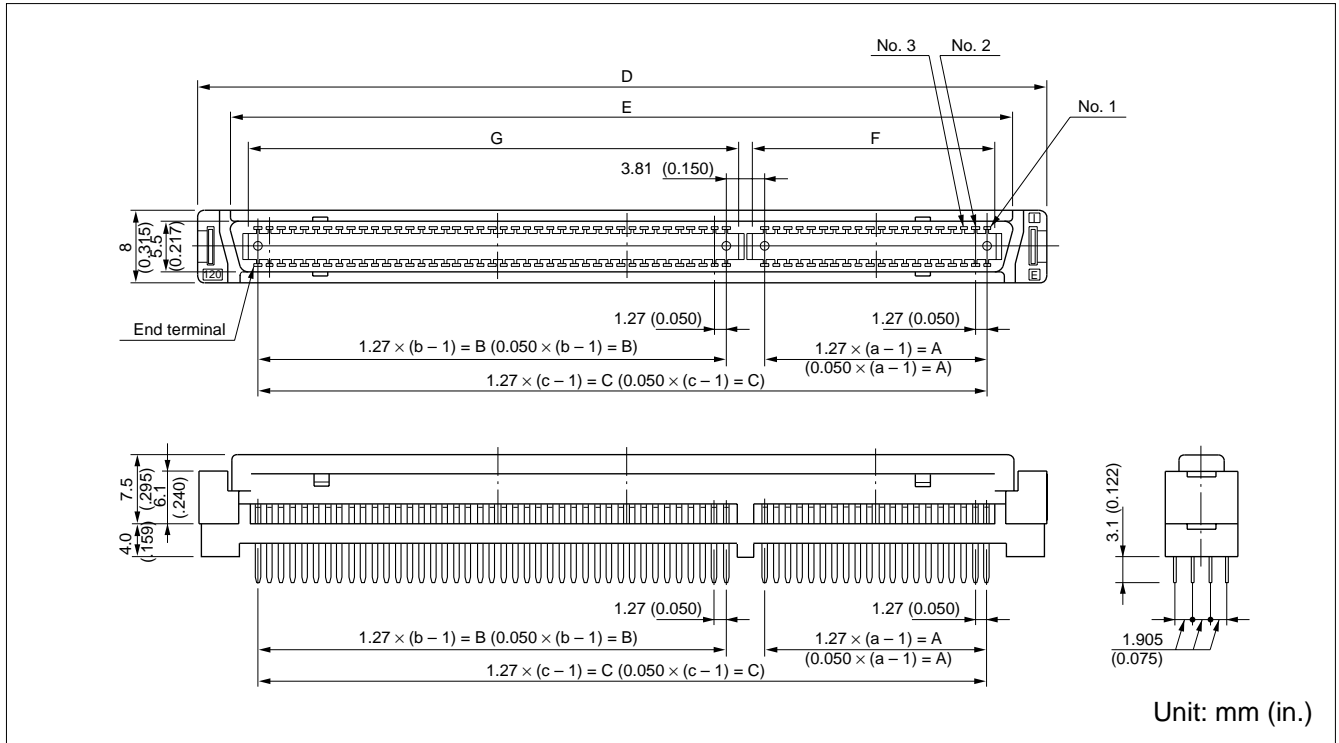

■ MOUNTING HOLE LAYOUT (COMPONENT SIDE)

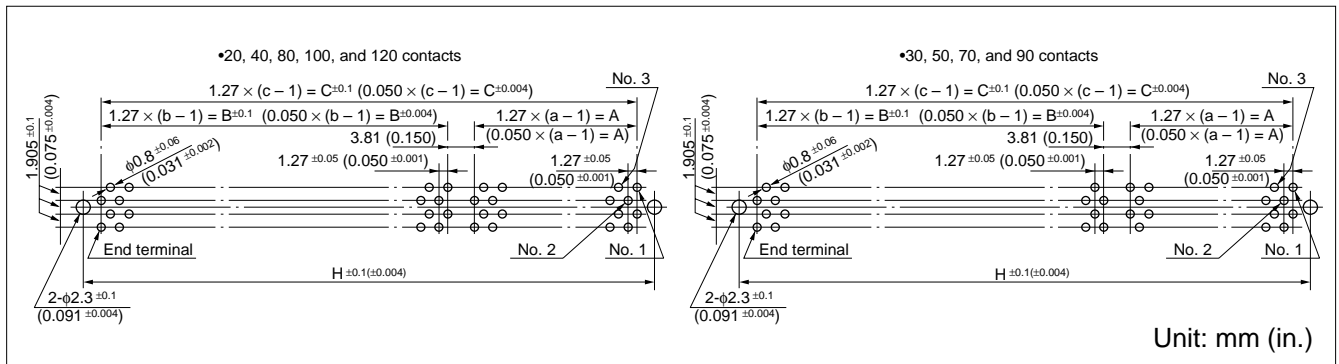

Connectors without a board lock do not require the mounting holes of 2-φ2.3 mm (0.091 in.) at both ends.

■ PART NUMBERS AND DIMENSIONS

Number of contacts	Part number	Dimensions: mm (in.)										
		a	A	b	B	c	C	D	E	F	G	H
20	FCN-244F020-G/6	—	—	—	—	10 (0.394)	11.43(0.450)	24.05(0.947)	19.27(0.759)	13.43(0.680)	—	21.40(0.843)
30	FCN-244F030-G/6	—	—	—	—	15 (0.591)	17.78(0.700)	30.40(1.197)	25.62(1.009)	19.78(0.930)	—	27.75(1.093)
40	FCN-244F040-G/6	—	—	—	—	20 (0.787)	24.13(0.950)	36.75(1.447)	31.97(1.259)	26.13(1.180)	—	34.10(1.343)
50	FCN-244F050-G/6	—	—	—	—	25 (0.984)	30.48(1.200)	43.10(1.697)	38.32(1.509)	32.48(1.430)	—	40.45(1.593)
60	FCN-244F060-G/6	—	—	—	—	30 (1.181)	36.83(1.450)	49.45(1.947)	44.67(1.759)	38.83(1.680)	—	46.80(1.845)
70	FCN-244F070-G/6	—	—	—	—	35 (1.378)	43.18(1.700)	55.80(2.197)	51.02(2.009)	45.18(1.930)	—	53.15(2.093)
80	FCN-244F080-G/6	—	—	—	—	40 (1.575)	49.53(1.950)	62.15(2.447)	57.37(2.259)	51.53(2.180)	—	59.50(2.343)
90	FCN-244F090-G/6	—	—	—	—	45 (1.772)	55.88(2.200)	68.50(2.697)	63.15(2.517)	57.88(2.426)	—	65.85(2.593)
100	FCN-244F100-G/6	—	—	—	—	50 (1.969)	62.23(2.450)	74.85(2.947)	70.07(2.759)	64.23(2.680)	—	72.20(2.843)
120	FCN-244F120-G/6	20 (0.787)	24.13(0.950)	40 (1.575)	49.53(1.950)	—	77.47(3.050)	90.09(3.547)	85.31(3.359)	25.93(3.280)	51.33(2.021)	87.44(3.443)

Connectors with board lock brackets are also available. Specify a part number by replacing -G/6 at the end with -G/G.

240 Series (Low-Profile Stacking)

Fujitsu Components International Headquarter Offices

Japan

Fujitsu Component Limited
Gotanda-Chuo Building
3-5, Higashigotanda 2-chome, Shinagawa-ku
Tokyo 141-0022, Japan
Tel: (81-3) 5449-7010
Fax: (81-3) 5449-2626
Email: promothq@fcl.fujitsu.com
Web: www.fcl.fujitsu.com

North and South America

Fujitsu Components America, Inc.
250 E. Caribbean Drive
Sunnyvale, CA 94089 U.S.A.
Tel: (1-408) 745-4900
Fax: (1-408) 745-4970
Email: components@us.fujitsu.com
Web: <http://us.fujitsu.com/components>

Europe

Fujitsu Components Europe B.V.
Diamantlaan 25
2132 WV Hoofddorp
Netherlands
Tel: (31-23) 5560910
Fax: (31-23) 5560950
Email: info@fceu.fujitsu.com
Web: emea.fujitsu.com/components

Asia Pacific

Fujitsu Components Asia Ltd.
102E Pasir Panjang Road
#01-01 Citilink Warehouse Complex
Singapore 118529
Tel: (65) 6375-8560
Fax: (65) 6273-3021
Email: fcal@fcal.fujitsu.com
www.fcal.fujitsu.com

© 2007 Fujitsu Components America, Inc. All rights reserved. All trademarks or registered trademarks are the property of their respective owners. Fujitsu Components America, Inc. or its affiliates do not warrant that the content of the datasheet is error free. In a continuing effort to improve our products, Fujitsu Components America, Inc. or its affiliates reserve the right to change specifications/datasheets without prior notice. Rev. November 2, 2007.